

High-PSRR, Low-Noise, Low-Dropout, 300mA CMOS Linear Regulator

General Description

The EMP2133 series is a family of dual-channel CMOS linear regulators featuring ultra-high power supply rejection ratio (PSRR), low output voltage noise, low dropout voltage, low quiescent current and fast transient response. It guarantees delivery of 300mA output current per regulator, and supports preset output voltages ranging from 1.2V to 3.3V with 0.1V increment (except for 1.85V and 2.85V).

The EMP2133 is well suited for portable battery-powered application which requires high efficiency, low noise and small board space. With 130mV low dropout voltage at 300mA output current, EMP2133 sustains high PSRR at very low input voltage which is common in battery-powered application. The EMP2133 also features 110µV_{RMS} low output voltage noise without the presence of a noise bypass capacitor, which fits the application where noise and board space are both concerned.

Each regulator in the EMP2133 can be turned off independently, further prolonging the battery life. Internally built-in thermal protection and over-current protection provide additional safety for the end use. The EMP2133 is available in miniature SOT-23-6 and TSOP-6 package.

■ Typical Application Diagram

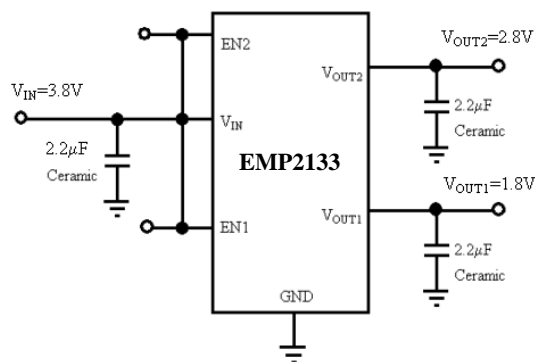

Features

- Miniature SOT-23-6 package
- 300mA guaranteed output current
- 70dB typical PSRR at 1kHz (55dB typical at 10kHz)
- 110µV_{RMS} output voltage noise (10Hz to 100kHz)
- 130mV typical dropout at 300mA
- 150µA typical quiescent current
- Less than 1µA typical shutdown mode
- Auto-discharge during chip disable
- Fast line and load transient response
- 35µs typical turn-on time
- 2.5V to 5.5V input range
- Stable with small ceramic output capacitors
- Over temperature and over current protection
- ±2% output voltage tolerance

Applications

- Wireless handsets
- PCMCIA cards
- DSP core power
- Hand-held instruments
- Battery-powered systems
- Portable information appliances

■ Typical Performance Characteristics

PSRR vs. Frequency

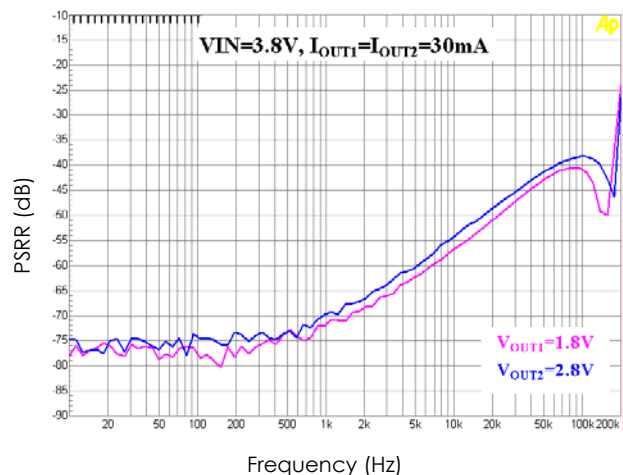

Pin Configuration

SOT-23-6

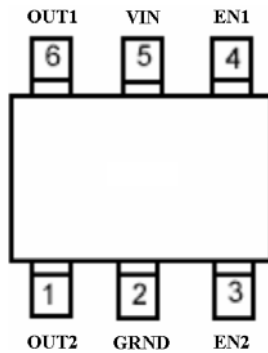

Order information

EMP2133-XXVC06GRR

XX Voltage Code

VC06 SOT-23-6 Package

GRR RoHS & Halogen free

Rating: -40 to 85°C

Package in Tape & Reel

Pin Functions

Name	SOT-23-6 TSOP-6	Function
OUT2	1	Output Voltage Feedback of Regulator 2
GRND	2	Ground Pin.
EN2	3	Enable Input of Regulator 2. Set regulator 2 into the disable mode by pulling the EN2 pin low. To keep regulator 2 on during normal operation, connect the EN2 pin to VIN. The EN2 pin must not exceed VIN under all operating conditions.
EN1	4	Enable Input of Regulator 1. Set regulator 1 into the disable mode by pulling the EN1 pin low. To keep regulator 1 on during normal operation, connect the EN1 pin to VIN. The EN1 pin must not exceed VIN under all operating conditions.
VIN	5	Supply Voltage Input. Require a minimum input capacitor of close to 1 μ F to ensure stability and sufficient decoupling from the ground pin.
OUT1	6	Output Voltage Feedback of Regulator 1

Order, Mark & Packing Information

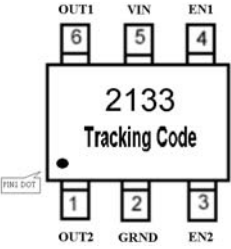
No. of PIN	EN1	EN2	Vout1	Vout2	Marking	Product ID	Package
6	Y	Y	3.0	3.0		EMP2133-00VC06GRR	3K units Tape & Reel
			1.8	3.0		EMP2133-01VC06GRR	3K units Tape & Reel
			1.8	2.8		EMP2133-02VC06GRR	3K units Tape & Reel
			2.5	3.3		EMP2133-03VC06GRR	3K units Tape & Reel
			2.8	3.3		EMP2133-04VC06GRR	3K units Tape & Reel
			1.8	3.3		EMP2133-05VC06GRR	3K units Tape & Reel
			2.85	2.85		EMP2133-06VC06GRR	3K units Tape & Reel
			2.8	1.8		EMP2133-07VC06GRR	3K units Tape & Reel
			3.3	2.8		EMP2133-08VC06GRR	3K units Tape & Reel
			2.5	1.8		EMP2133-10VC06GRR	3K units Tape & Reel
			1.2	2.8		EMP2133-11VC06GRR	3K units Tape & Reel
			1.5	2.8		EMP2133-12VC06GRR	3K units Tape & Reel

Absolute Maximum Ratings (Notes 1, 2)

V _{IN} , V _{OUT1} , V _{OUT2} , V _{EN1} , V _{EN2}	-0.3V to 6.5V		
Power Dissipation	(Note 3)	Thermal Resistance (θ _{JA})	
Storage Temperature Range	-65°C to 160°C	SOT-23-6	250°C/W
Junction Temperature (T _J)	150°C		
Lead Temperature (10 sec.)	260°C	Operating Ratings (Note 1, 2)	
ESD Rating		Temperature Range	-40°C to 85°C
HBM (Note 5)	2KV	Supply Voltage	2.5V to 5.5V
MM	200V		

Electrical Characteristics

Unless otherwise specified, all limits guaranteed for V_{IN} = V_{OUT} + 1V (Note 6), V_{EN1} = V_{EN2} = V_{IN}, C_{IN} = C_{OUT} = 2.2μF, T_J = 25°C. **Boldface** limits apply for the operating temperature extremes: -40°C and 85°C.

Symbol	Parameter	Conditions	Min	Typ (Note 7)	Max	Units
V _{IN}	Input Voltage		2.5		5.5	V
ΔV _{OTL}	Output Voltage Tolerance	I _{OUT} = 30mA V _{IN} = V _{OUT(NOM)} + 1V, (Note 6)	-2		+2	% of V _{OUT(NOM)}
I _{OUT}	Maximum Output Current	Average DC Current Rating	300			mA
I _{LIMIT}	Output Current Limit			600		mA
I _Q	Supply Current	I _{OUT1} = I _{OUT2} = 0mA		150		μA
		I _{OUT1} = I _{OUT2} = 300mA		250		
	Shutdown Supply Current	EN1 = EN2 = GND		0.001		
V _{DO}	Dropout Voltage (Note 4), (Note 6)	I _{OUT} = 30mA		13		mV
		I _{OUT} = 300mA		130		
PSRR	Power-supply rejection ratio V _{IN} =3.8V, V _{OUT} =2.8V I _{OUT} =10mA	f = 100Hz		75		dB
		f = 1kHz		70		
		f = 10kHz		55		
	Power-supply rejection ratio V _{IN} =3.8V, V _{OUT} =2.8V I _{OUT} =150mA	f = 100Hz		68		
		f = 1kHz		68		
		f = 10kHz		55		
ΔV _{OUT}	Line Regulation	I _{OUT} = 30mA, (V _{OUT} + 1V) ≤ V _{IN} ≤ 5.5V, (Note 6)	-0.1	0.01	0.1	%/V
	Load Regulation	1mA ≤ I _{OUT} ≤ 300mA		0.0003		%/mA
e _n	Output Voltage Noise	V _{OUT} =2.8V, I _{OUT} = 30mA, 10Hz ≤ f ≤ 100kHz (Note 8)		110		μV _{RMS}
V _{EN}	Enable Input Threshold	V _{IH} , (V _{OUT} + 0.5V) ≤ V _{IN} ≤ 5.5V (Note 6)	1.2			V
		V _{IL} , (V _{OUT} + 0.5V) ≤ V _{IN} ≤ 5.5V (Note 6)			0.4	
T _{SD}	Thermal Shutdown Temperature			170		°C
	Thermal Shutdown Hysteresis			30		

T _{ON}	Turn-On Time	V _{OUT} at 95% of Final Value		35		μs
T _{OFF}	Turn-Off Time	I _{OUT} =0mA (Note 9)		2.4		ms

Note 1: Absolute Maximum ratings indicate limits beyond which damage may occur. Electrical specifications are not applicable when the device is operated outside of its rated operating conditions.

Note 2: All voltages are defined and measured with respect to the potential at the ground pin.

Note 3: Maximum Power dissipation for the device is calculated using the following equations:

$$P_D = \frac{T_{J(MAX)} - T_A}{\theta_{JA}}$$

where T_{J(MAX)} is the maximum junction temperature, T_A is the ambient temperature, and θ_{JA} is the junction-to-ambient thermal resistance. E.g. for the SOT-23-6 package θ_{JA} = 250°C/W, T_{J(MAX)} = 150°C and using T_A = 25°C, the maximum power dissipation is found to be 500mW. The derating factor (-1/θ_{JA}) = -4mW/°C, thus below 25°C the power dissipation figure can be increased by 4mW per degree, and similarly decreased by this factor for temperatures above 25°C.

Note 4: Dropout voltage is measured by reducing V_{IN} until V_{OUT} drops 100mV from its nominal value at V_{IN} - V_{OUT} = 1V. Dropout voltage does not apply to the regulator versions with V_{OUT} less than 2.5V.

Note 5: Human body model: 1.5kΩ in series with 100pF.

Note 6: Condition does not apply to input voltages below 2.5V since this is the minimum input operating voltage.

Note 7: Typical Values represent the most likely parametric norm.

Note 8: For different output voltage, the noise can be approximately calculated using the following formula:

$$Noise = V_{OUT} \times 38 (\mu V_{RMS})$$

Note 9: Turn-off time is time measured between the enable input just decreasing below V_{IL} and the output voltage just decreasing to 10% of its nominal value.

Functional Block Diagram

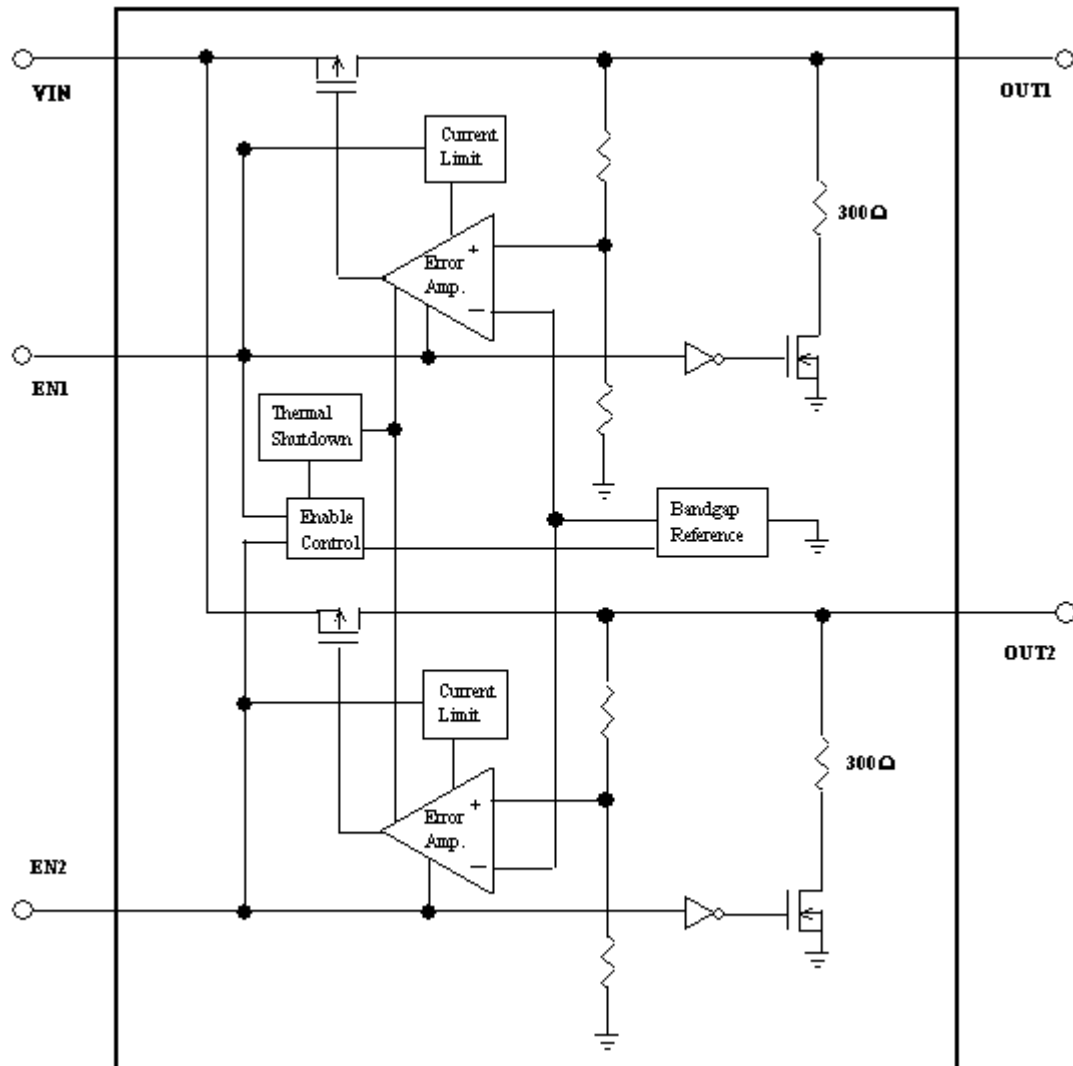

Typical Performance Characteristics

Unless otherwise specified, $V_{IN} = V_{OUT(NOM)} + 1V$, $C_{IN} = C_{OUT} = 2.2\mu F$, $T_A = 25^\circ C$, $V_{EN1} = V_{EN2} = V_{IN}$.

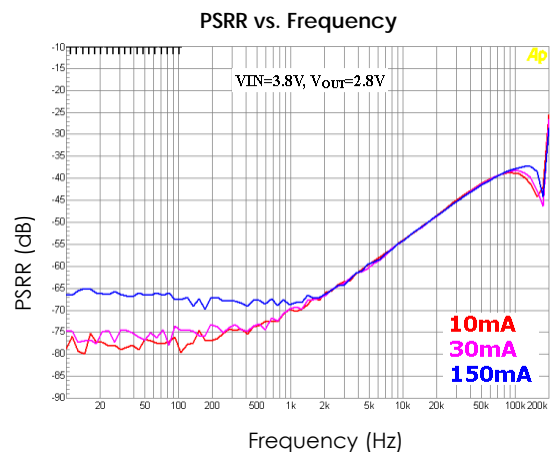
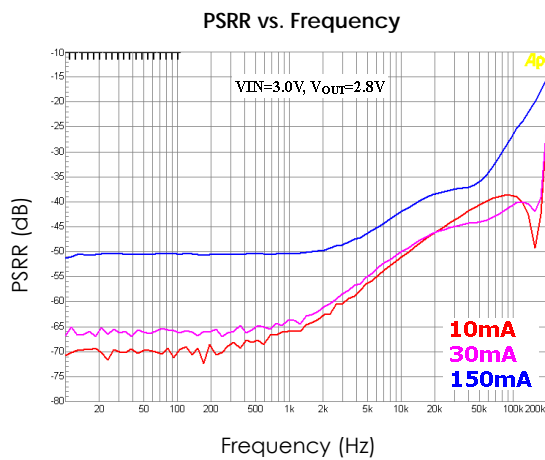
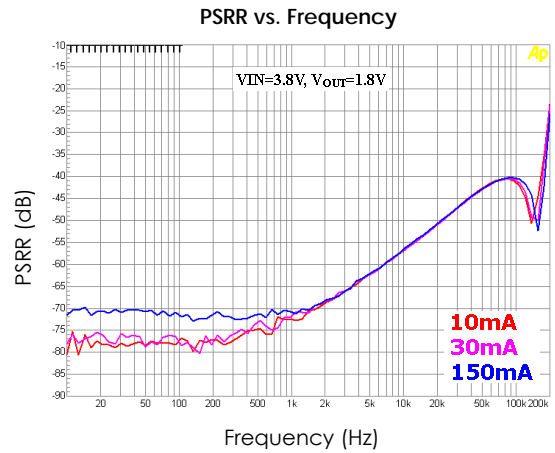
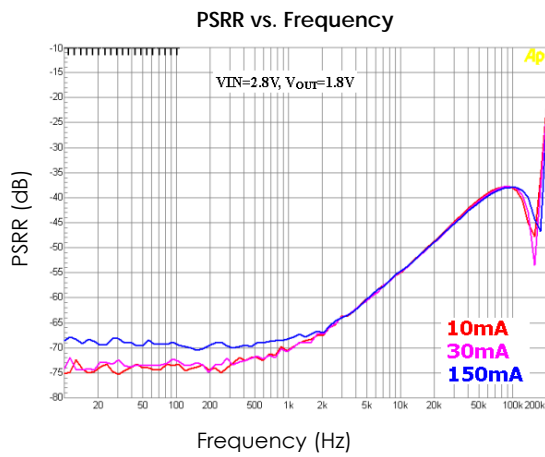
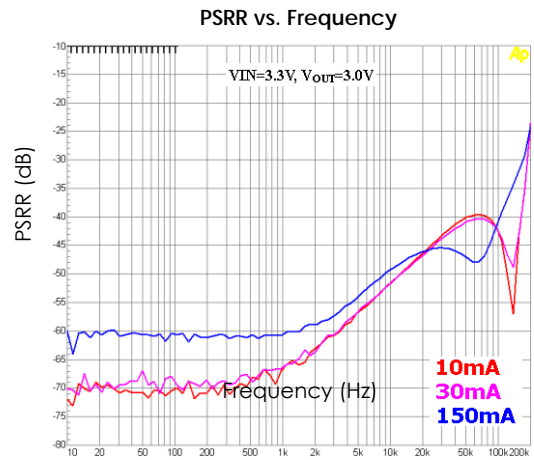
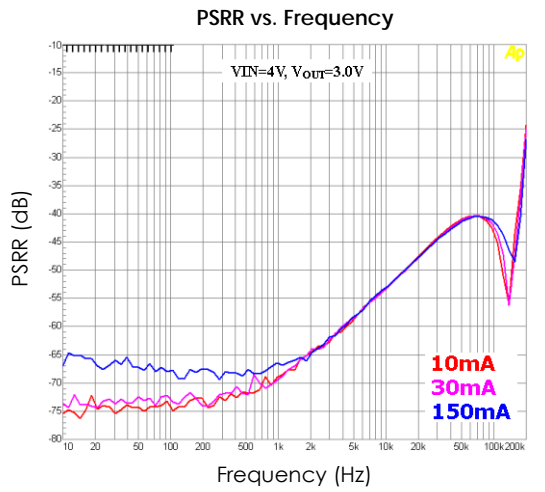

Typical Performance Characteristics

Unless otherwise specified, $V_{IN} = V_{OUT(NOM)} + 1V$, $C_{IN} = C_{OUT} = 2.2\mu F$, $T_A = 25^\circ C$, $V_{EN1} = V_{EN2} = V_{IN}$. (Continued)

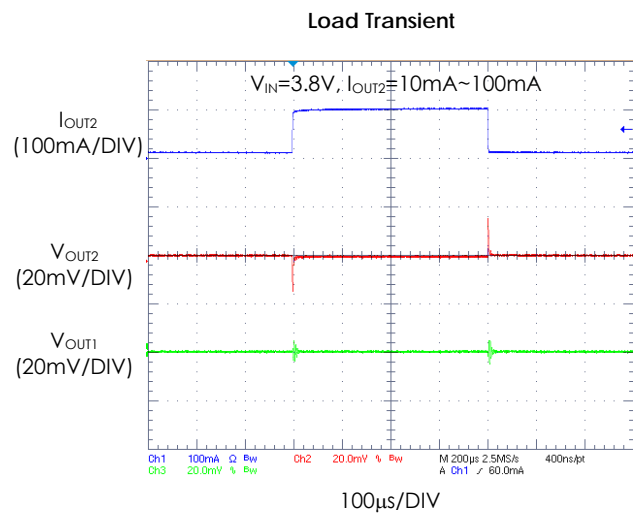
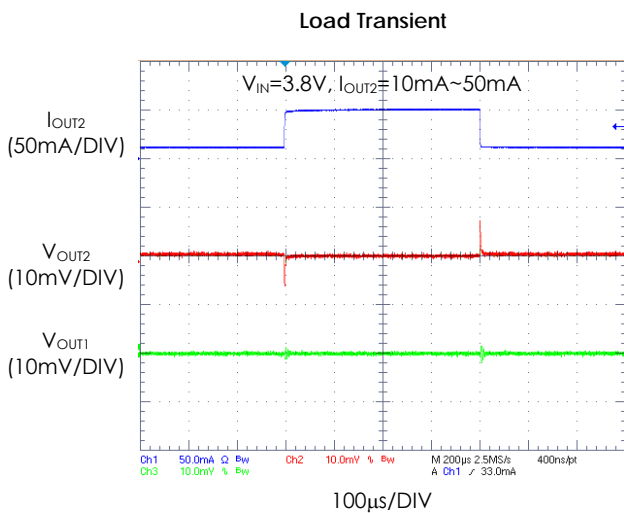
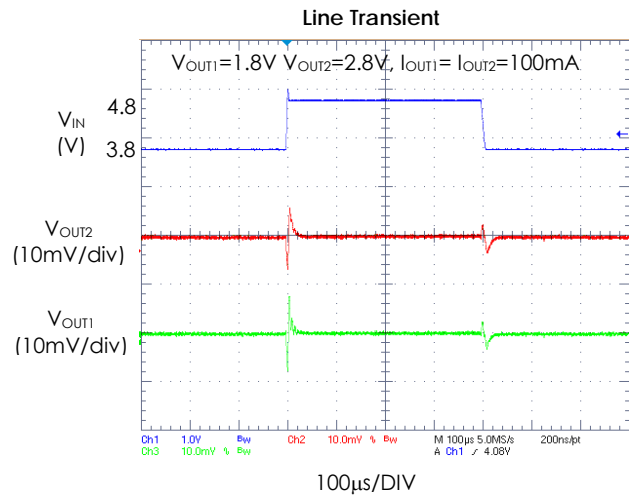
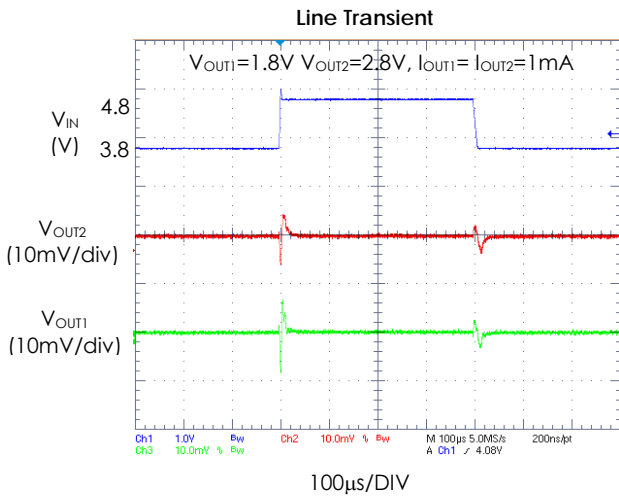
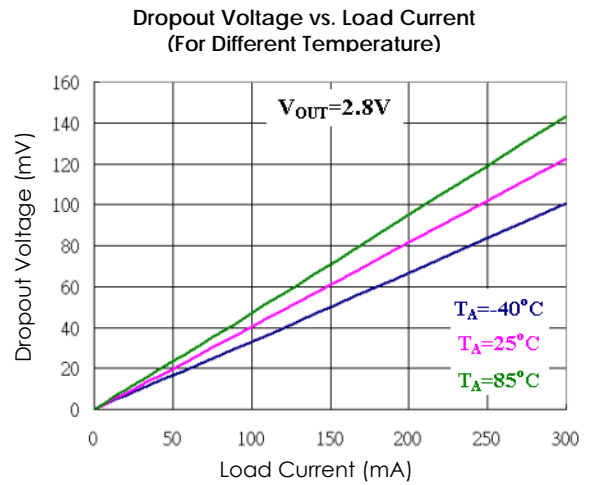
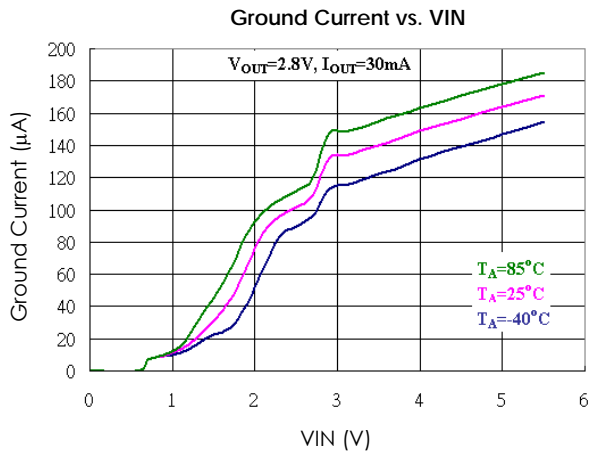

Typical Performance Characteristics

Unless otherwise specified, $V_{IN} = V_{OUT(NOM)} + 1V$, $C_{IN} = C_{OUT} = 2.2\mu F$, $T_A = 25^\circ C$, $V_{EN1} = V_{EN2} = V_{IN}$. (Continued)

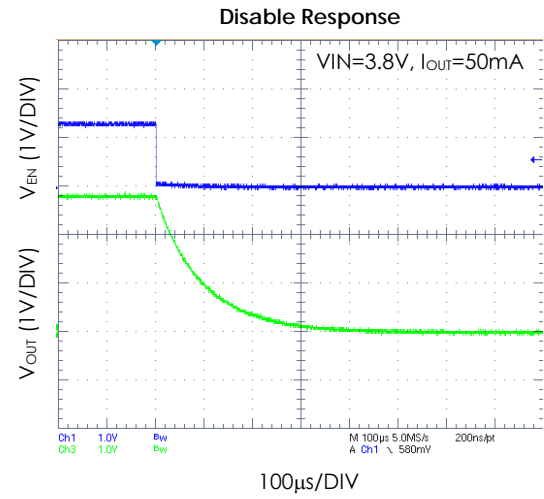
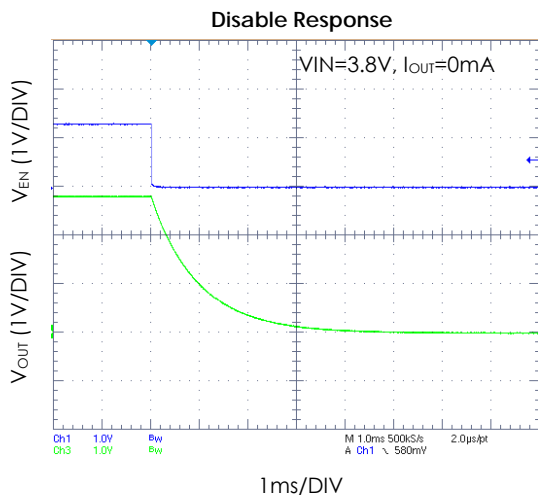
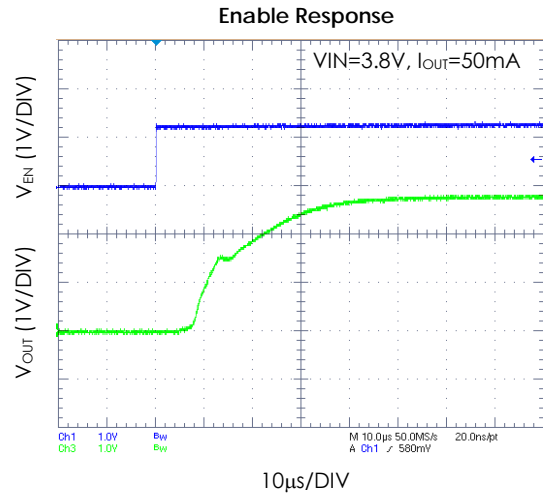
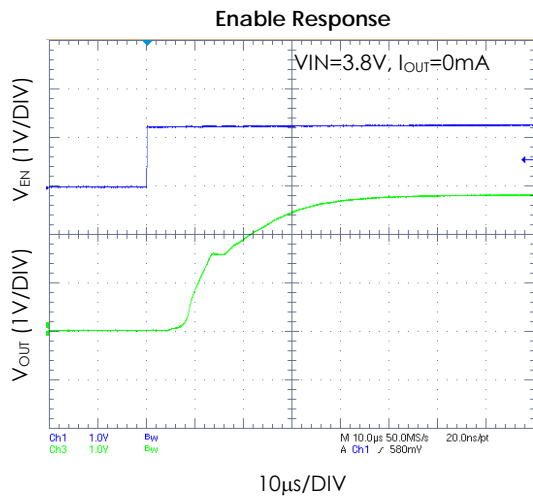

Physical Dimensions SOT-23-6

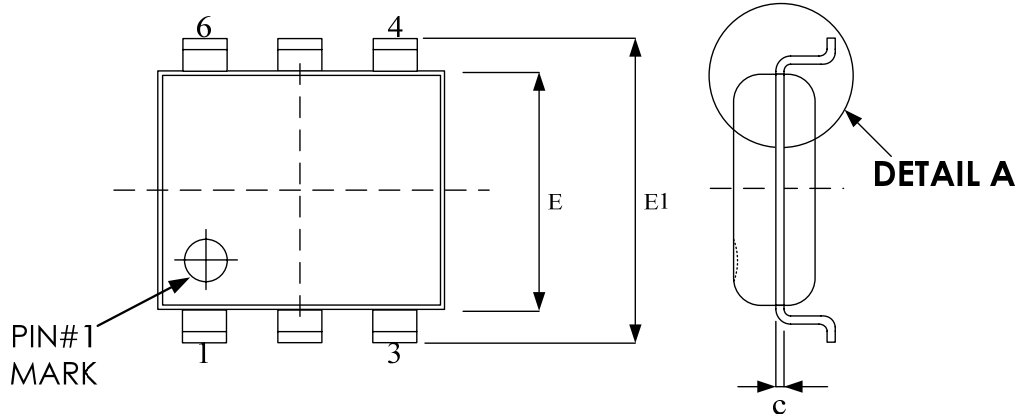

TOP VIEW

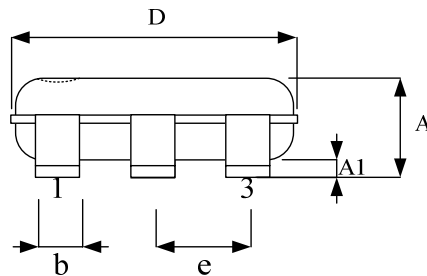

SIDE VIEW

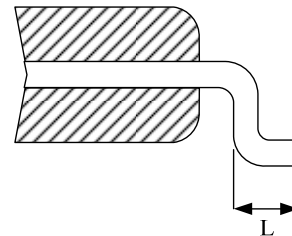

DETAIL A

Symbol	Dimension in mm	
	Min.	Max.
A	0.90	1.45
A1	0.00	0.15
b	0.30	0.50
c	0.08	0.25
D	2.70	3.10
E	1.40	1.80
E1	2.60	3.00
e	0.95 BSC	
L	0.30	0.60

Old Order, Mark & Packing Information

No. of PIN	EN1	EN2	Vout1	Vout2	Option	Old Marking	Package
6	Y	Y	3.0	3.0	00	1300 Date code	3K units Tape & Reel
			1.8	3.0	01	1301 Date code	3K units Tape & Reel
			1.8	2.8	02	1302 Date code	3K units Tape & Reel
			2.5	3.3	03	1303 Date code	3K units Tape & Reel
			2.8	3.3	04	1304 Date code	3K units Tape & Reel
			1.8	3.3	05	1305 Date code	3K units Tape & Reel
			2.85	2.85	06	1306 Date code	3K units Tape & Reel

Revision History

Revision	Date	Description
3.0	2009.06.08	EMP transferred from version 2.3
3.1	2013.02.18	1.Revise GRR definition 2.Add product ID EMP2133-12VC06GRR 3.Revise SOT23-6 outline spec

Important Notice

All rights reserved.

No part of this document may be reproduced or duplicated in any form or by any means without the prior permission of ESMT.

The contents contained in this document are believed to be accurate at the time of publication. ESMT assumes no responsibility for any error in this document, and reserves the right to change the products or specification in this document without notice.

The information contained herein is presented only as a guide or examples for the application of our products. No responsibility is assumed by ESMT for any infringement of patents, copyrights, or other intellectual property rights of third parties which may result from its use. No license, either express, implied or otherwise, is granted under any patents, copyrights or other intellectual property rights of ESMT or others.

Any semiconductor devices may have inherently a certain rate of failure. To minimize risks associated with customer's application, adequate design and operating safeguards against injury, damage, or loss from such failure, should be provided by the customer when making application designs.

ESMT's products are not authorized for use in critical applications such as, but not limited to, life support devices or system, where failure or abnormal operation may directly affect human lives or cause physical injury or property damage. If products described here are to be used for such kinds of application, purchaser must do its own quality assurance testing appropriate to such applications.