

## Dual, High-PSRR, Low-Noise, Low-Dropout, 300mA CMOS Linear Regulator

### General Description

The EMP6403 series is a family of dual-channel CMOS linear regulators featuring ultra-high power supply rejection ratio (PSRR), low output voltage noise, low dropout voltage, low quiescent current and fast transient response. It guarantees delivery of 300mA output current per regulator, and supports preset output voltages ranging from 1.2V to 3.3V with 0.1V increment (except for 1.85V and 2.85V).

The EMP6403 is well suited for portable battery-powered application which requires high efficiency, low noise and small board space. With 150mV low dropout voltage at 300mA output current, EMP6403 sustains high PSRR at very low input voltage which is common in battery-powered application. The EMP6403 also features 120 $\mu$ V<sub>RMS</sub> low output voltage noise without the presence of a noise bypass capacitor, which fits the application where noise and board space are both concerned.

Each regulator in the EMP6403 can be turned off independently, further prolonging the battery life. Internally built-in thermal protection and over-current protection provide additional safety for the end use. The EMP6403 is available in miniature 6-pin SOT-23-6 packages.

#### ■ Typical Application Diagram

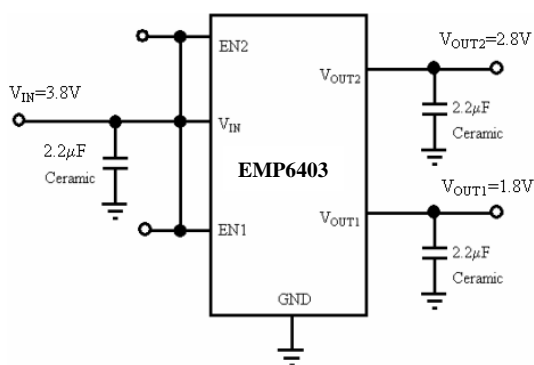

### Features

- Miniature SOT-23-6 packages
- 300mA guaranteed output current
- 72dB typical PSRR at 1kHz (60dB typical at 10kHz)
- 120 $\mu$ V<sub>RMS</sub> output voltage noise (10Hz to 100kHz)
- 150mV typical dropout at 300mA
- 150 $\mu$ A typical quiescent current
- Less than 1 $\mu$ A typical shutdown mode
- Auto-discharge during chip disable
- Fast line and load transient response
- 30 $\mu$ s typical turn-on time
- 2.5V to 5.5V input range
- Stable with small ceramic output capacitors
- Over temperature and over current protection
- $\pm$ 2% output voltage tolerance

### Applications

- Wireless handsets
- PCMCIA cards
- DSP core power
- Hand-held instruments
- Battery-powered systems
- Portable information appliances

#### ■ Typical Performance Characteristics

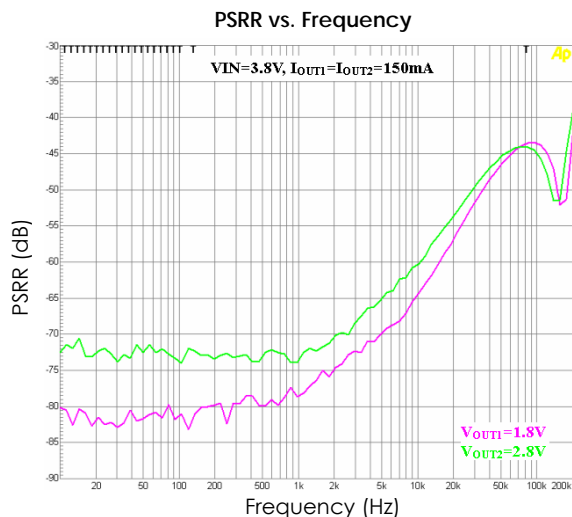

## CONNECTION DIAGRAM

SOT-23-6

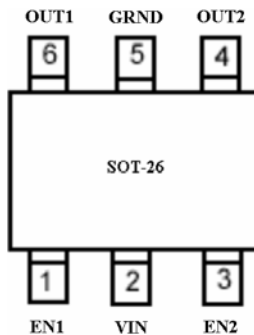

## ORDER INFORMATION

EMP6403-XXVC06GRR  
 XX Output voltage  
 VC06 SOT-23-6 Package  
 GRR RoHS & Halogen free  
 Rating: -40 to 85°C  
 Package in Tape & Reel

## Pin Functions

Name	SOT-23-6	Function
EN1	1	<b>Enable Input of Regulator 1.</b> Set regulator 1 into the disable mode by pulling the EN1 pin low. To keep regulator 1 on during normal operation, connect the EN1 pin to VIN. The EN1 pin must not exceed VIN under all operating conditions.
VIN	2	<b>Supply Voltage Input.</b> Require a minimum input capacitor of close to 1μF to ensure stability and sufficient decoupling from the ground pin.
EN2	3	<b>Enable Input of Regulator 2.</b> Set regulator 2 into the disable mode by pulling the EN2 pin low. To keep regulator 2 on during normal operation, connect the EN2 pin to VIN. The EN2 pin must not exceed VIN under all operating conditions.
OUT2	4	<b>Output Voltage Feedback of Regulator 2</b>
GRND	5	<b>Ground Pin.</b>
OUT1	6	<b>Output Voltage Feedback of Regulator 1</b>

## Order, Mark & Packing Information

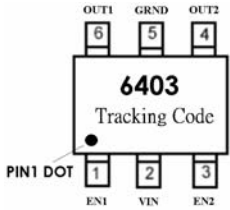
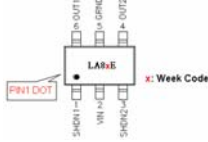
Package	No. of PIN	EN1	EN2	Marking	Vout1	Vout2	Product ID	Packing
SOT-23-6	6	Y	Y		3.0	3.0	EMP6403-00VC06GRR	3K units Tape & Reel
					1.8	3.0	EMP6403-01VC06GRR	3K units Tape & Reel
					1.8	2.8	EMP6403-02VC06GRR	3K units Tape & Reel
					2.5	3.3	EMP6403-03VC06GRR	3K units Tape & Reel
					2.8	3.3	EMP6403-04VC06GRR	3K units Tape & Reel
					1.8	3.3	EMP6403-05VC06GRR	3K units Tape & Reel
					2.85	2.85	EMP6403-06VC06GRR	3K units Tape & Reel
					1.5	2.8	EMP6403-07VC06GRR	3K units Tape & Reel
					1.2	2.8	EMP6403-11VC06GRR	3K units Tape & Reel
					1.2	1.8	EMP6403-15VC06GRR	3K units Tape & Reel
SOT-23-6	6	Y	Y		3.0	3.0	EMP6403-00VC06GRR	3K units Tape & Reel

## Absolute Maximum Ratings (Notes 1, 2)

$V_{IN}, V_{OUT1}, V_{OUT2}, V_{EN1}, V_{EN2}$	-0.3V to 6.5V	Thermal Resistance ( $\theta_{JA}$ )	
Power Dissipation	(Note 3)	6-pin SOT-23-6	250°C/W
Storage Temperature Range	-65°C to 160°C	6-pin FBP-6	(Note 3)
Junction Temperature ( $T_J$ )	150°C		
Lead Temperature (10 sec.)	260°C	<b>Operating Ratings</b> (Note 1, 2)	
ESD Rating		Temperature Range	-40°C to 85°C
HBM (Note 5)	2kV	Supply Voltage	2.5V to 5.5V
MM	200V		

## Electrical Characteristics

Unless otherwise specified, all limits guaranteed for  $V_{IN} = V_{OUT} + 1V$  (Note 6),  $V_{EN1} = V_{EN2} = V_{IN}$ ,  $C_{IN} = C_{OUT} = 2.2\mu F$ ,  $T_J = 25^\circ C$ .

**Boldface** limits apply for the operating temperature extremes: -40°C and 85°C.

Symbol	Parameter	Conditions	Min	Typ (Note 7)	Max	Units
$V_{IN}$	Input Voltage		<b>2.5</b>		<b>5.5</b>	V
$\Delta V_{OTL}$	Output Voltage Tolerance	$I_{OUT} = 30mA$ $V_{IN} = V_{OUT(NOM)} + 1V$ , (Note 6)	-2		+2	% of $V_{OUT(NOM)}$
$I_{OUT}$	Maximum Output Current	Average DC Current Rating	<b>300</b>			mA
$I_{LIMIT}$	Output Current Limit			600		mA
$I_Q$	Supply Current	$I_{OUT1} = I_{OUT2} = 0mA$		150		$\mu A$
		$I_{OUT1} = I_{OUT2} = 300mA$		250		
	Shutdown Supply Current	$EN1 = EN2 = GND$		0.001		
$V_{DO}$	Dropout Voltage (Note 4), (Note 6)	$I_{OUT} = 30mA$		15		mV
		$I_{OUT} = 100mA$		50		
		$I_{OUT} = 300mA$		150		
PSRR	Power-supply rejection ratio $V_{IN}=4.0V, V_{OUT}=3.0V$ $I_{OUT}=150mA$	$f = 1kHz$		72		dB
		$f = 10kHz$		60		
		$f = 100kHz$		43		
	Power-supply rejection ratio $V_{IN}=3.3V, V_{OUT}=3.0V$ $I_{OUT}=30mA$	$f = 1kHz$		70		
		$f = 10kHz$		57		
		$f = 100kHz$		42		
$\Delta V_{OUT}$	Line Regulation	$I_{OUT} = 30mA, (V_{OUT} + 1V) \leq V_{IN} \leq 5.5V$ , (Note 6)	-0.1	0.01	0.1	%/V
	Load Regulation	$1mA \leq I_{OUT} \leq 100mA$		6		mV
$1mA \leq I_{OUT} \leq 300mA$				20		
$e_n$	Output Voltage Noise	$V_{OUT}=2.8V, I_{OUT} = 30mA, 10Hz \leq f \leq 100kHz$ (Note 8)		120		$\mu V_{RMS}$
$V_{EN}$	Enable Input Threshold	$V_{IH}, (V_{OUT} + 0.5V) \leq V_{IN} \leq 5.5V$ (Note 6)	<b>1.2</b>			V
		$V_{IL}, (V_{OUT} + 0.5V) \leq V_{IN} \leq 5.5V$ (Note 6)			<b>0.4</b>	

T <sub>SD</sub>	Thermal Shutdown Temperature			170		°C
	Thermal Shutdown Hysteresis			30		
T <sub>ON</sub>	Turn-On Time	V <sub>OUT</sub> at 95% of Final Value		30		μs
T <sub>OFF</sub>	Turn-Off Time	I <sub>OUT</sub> =0mA (Note 9)		2.4		ms

**Note 1:** Absolute Maximum ratings indicate limits beyond which damage may occur. Electrical specifications are not applicable when the device is operated outside of its rated operating conditions.

**Note 2:** All voltages are defined and measured with respect to the potential at the ground pin.

**Note 3:** Maximum Power dissipation for the device is calculated using the following equations:

$$P_D = \frac{T_{J(MAX)} - T_A}{\theta_{JA}}$$

where T<sub>J(MAX)</sub> is the maximum junction temperature, T<sub>A</sub> is the ambient temperature, and θ<sub>JA</sub> is the junction-to-ambient thermal resistance. E.g. for the SOT-23-6 package θ<sub>JA</sub> = 250°C/W, T<sub>J(MAX)</sub> = 150°C and using T<sub>A</sub> = 25°C, the maximum power dissipation is found to be 500mW. The derating factor (-1/θ<sub>JA</sub>) = -4mW/°C, thus below 25°C the power dissipation figure can be increased by 4mW per degree, and similarly decreased by this factor for temperatures above 25°C. The value of the θ<sub>JA</sub> for the FBP-6 package is specifically dependent on the PCB trace area, trace material, and the number of layers and thermal vias.

**Note 4:** Dropout voltage is measured by reducing V<sub>IN</sub> until V<sub>OUT</sub> drops 100mV from its nominal value at V<sub>IN</sub> - V<sub>OUT</sub> = 1V. Dropout voltage does not apply to the regulator versions with V<sub>OUT</sub> less than 2.5V.

**Note 5:** Human body model: 1.5kΩ in series with 100pF.

**Note 6:** Condition does not apply to input voltages below 2.5V since this is the minimum input operating voltage.

**Note 7:** Typical Values represent the most likely parametric norm.

**Note 8:** For different output voltage, the noise can be approximately calculated using the following formula:

$$Noise = V_{OUT} \times 42 (\mu V_{RMS})$$

**Note 9:** Turn-off time is time measured between the enable input just decreasing below V<sub>IL</sub> and the output voltage just decreasing to 10% of its nominal value.

## Functional Block Diagram

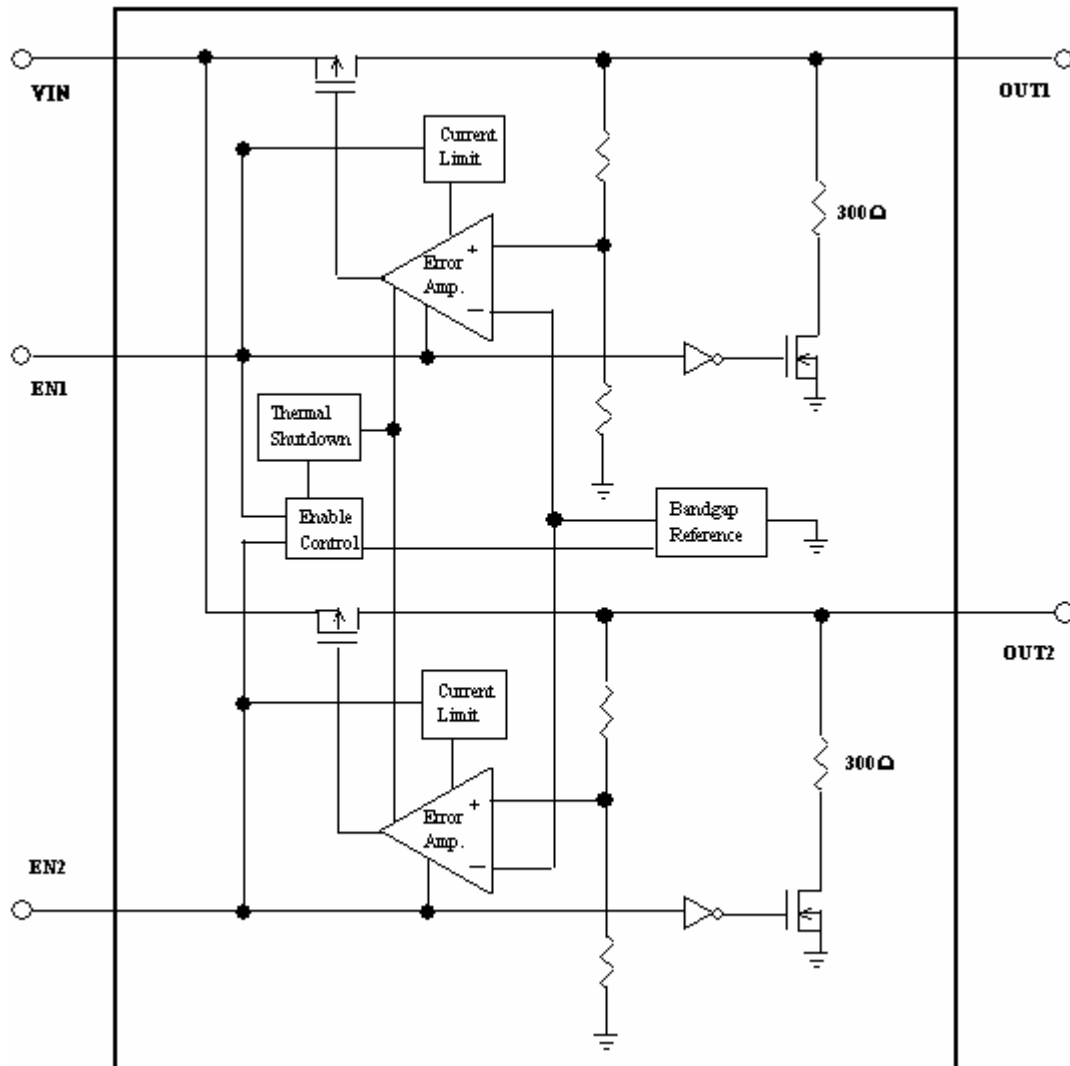

## Typical Performance Characteristics

Unless otherwise specified,  $V_{IN} = V_{OUT(NOM)} + 1V$ ,  $C_{IN} = C_{OUT} = 2.2\mu F$ ,  $T_A = 25^\circ C$ ,  $V_{EN1} = V_{EN2} = V_{IN}$ .

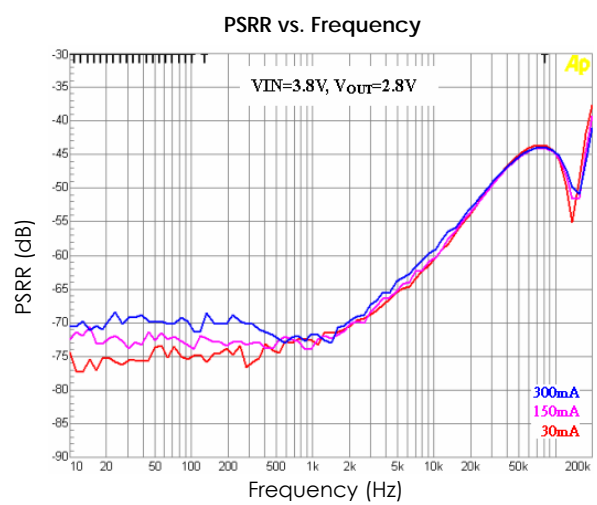
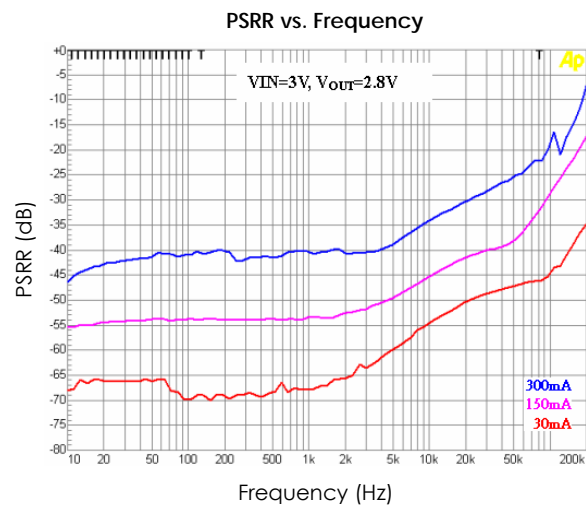
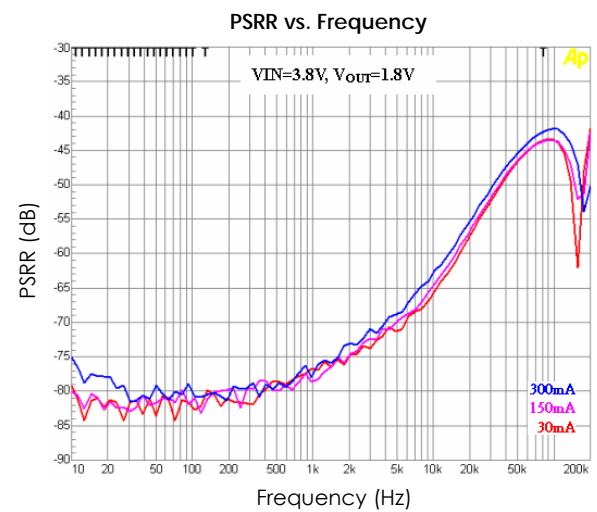
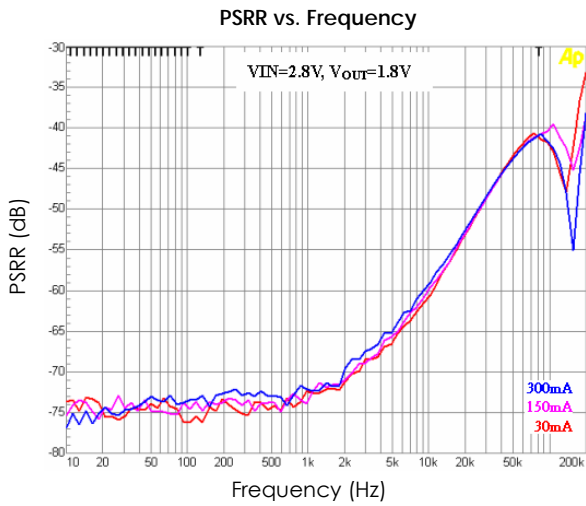
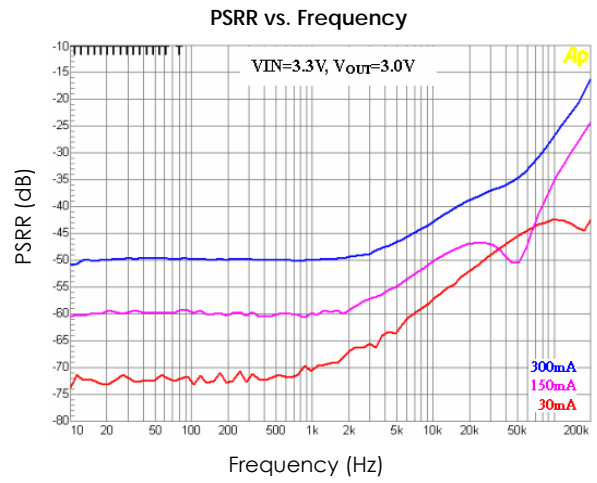
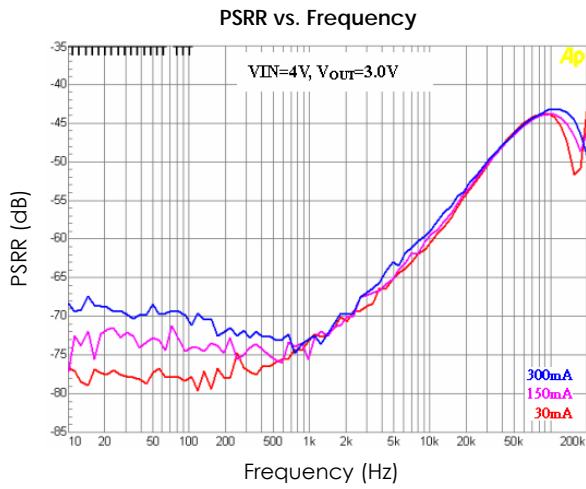

## Typical Performance Characteristics

Unless otherwise specified,  $V_{IN} = V_{OUT(NOM)} + 1V$ ,  $C_{IN} = C_{OUT} = 2.2\mu F$ ,  $T_A = 25^\circ C$ ,  $V_{EN1} = V_{EN2} = V_{IN}$ . (Continued)

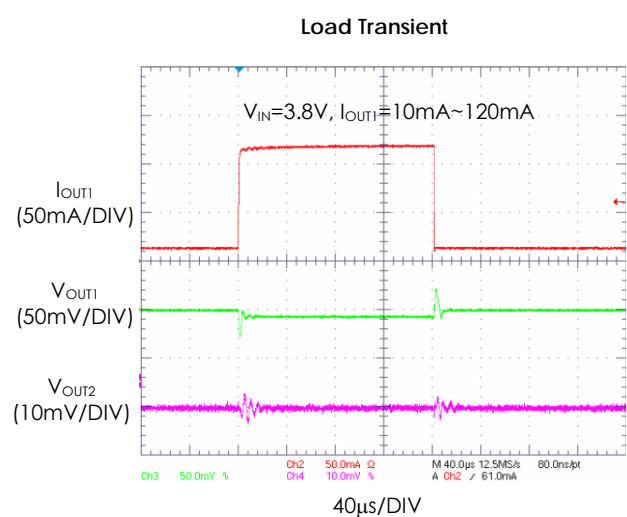
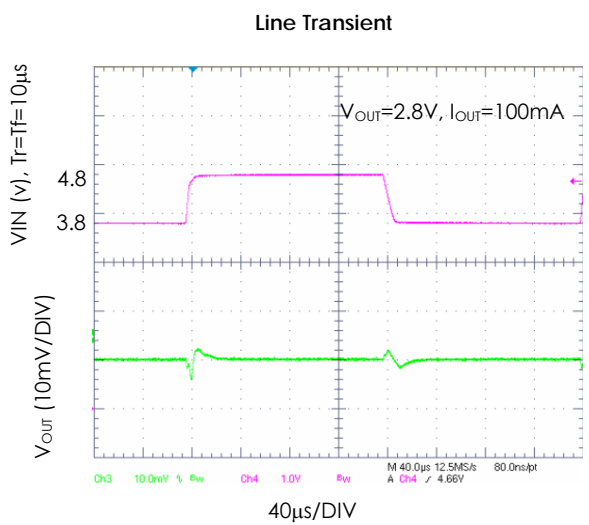
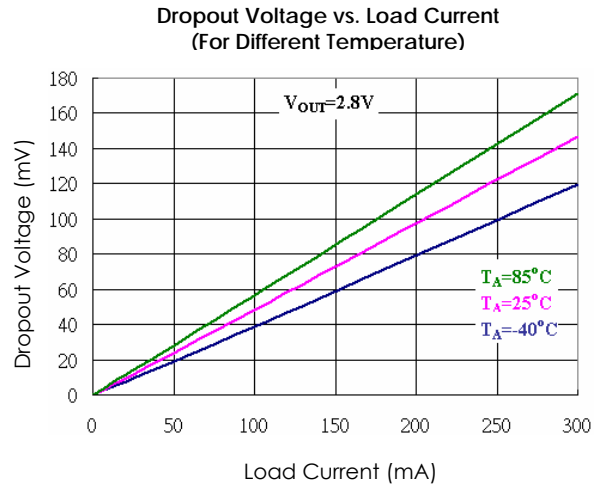
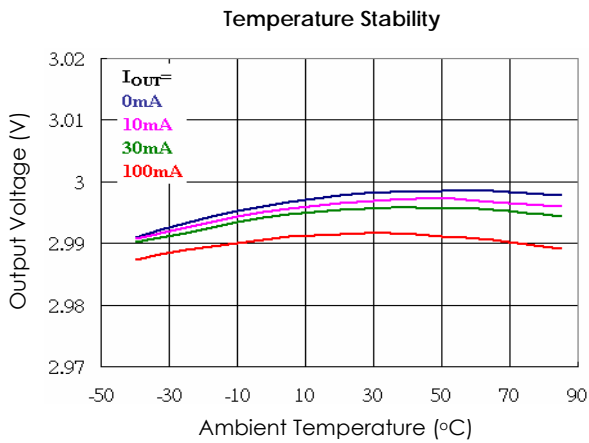
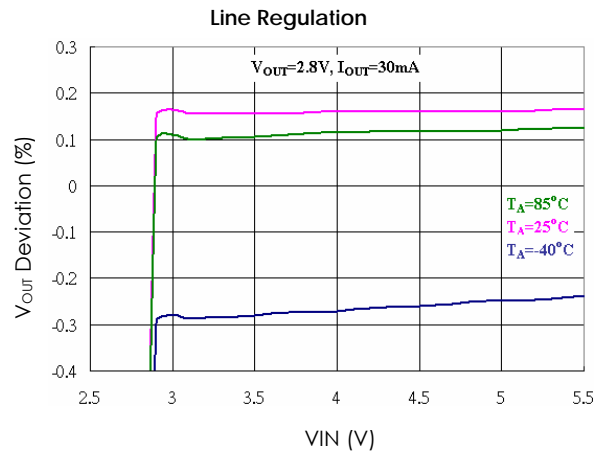
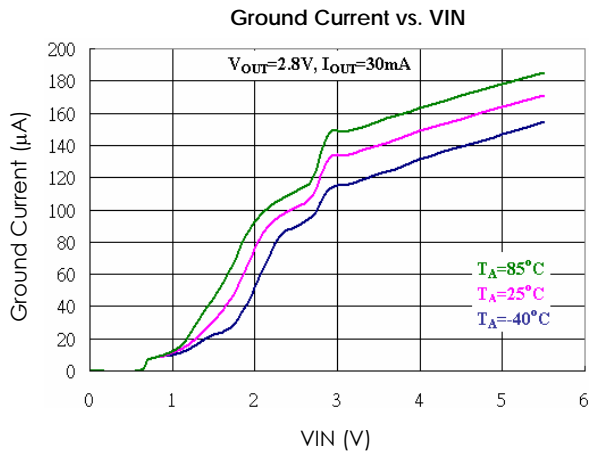



## Typical Performance Characteristics

Unless otherwise specified,  $V_{IN} = V_{OUT(NOM)} + 1V$ ,  $C_{IN} = C_{OUT} = 2.2\mu F$ ,  $T_A = 25^\circ C$ ,  $V_{EN1} = V_{EN2} = V_{IN}$ . (Continued)

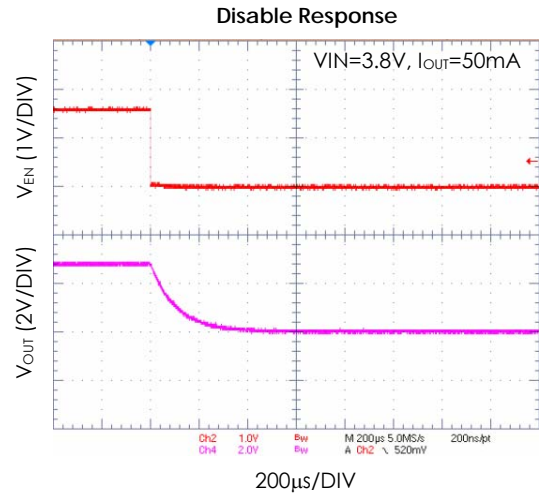
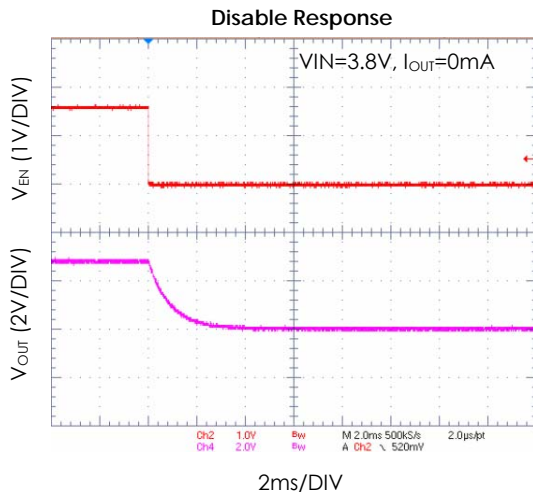
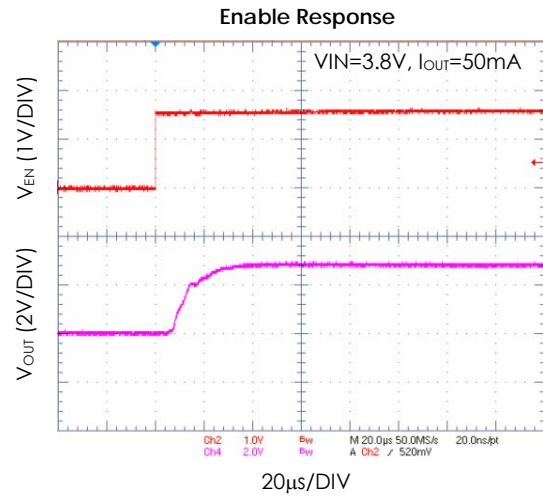
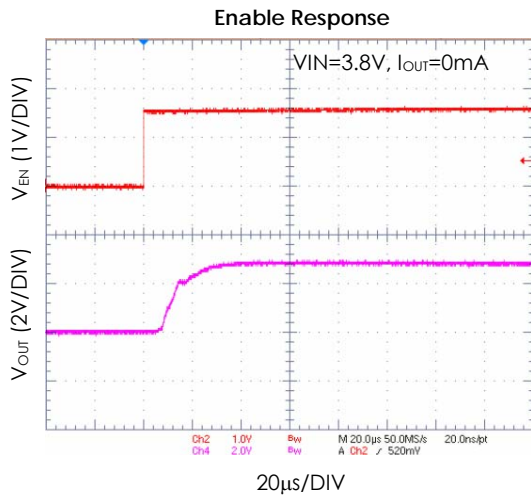

## Physical Dimensions SOT-23-6

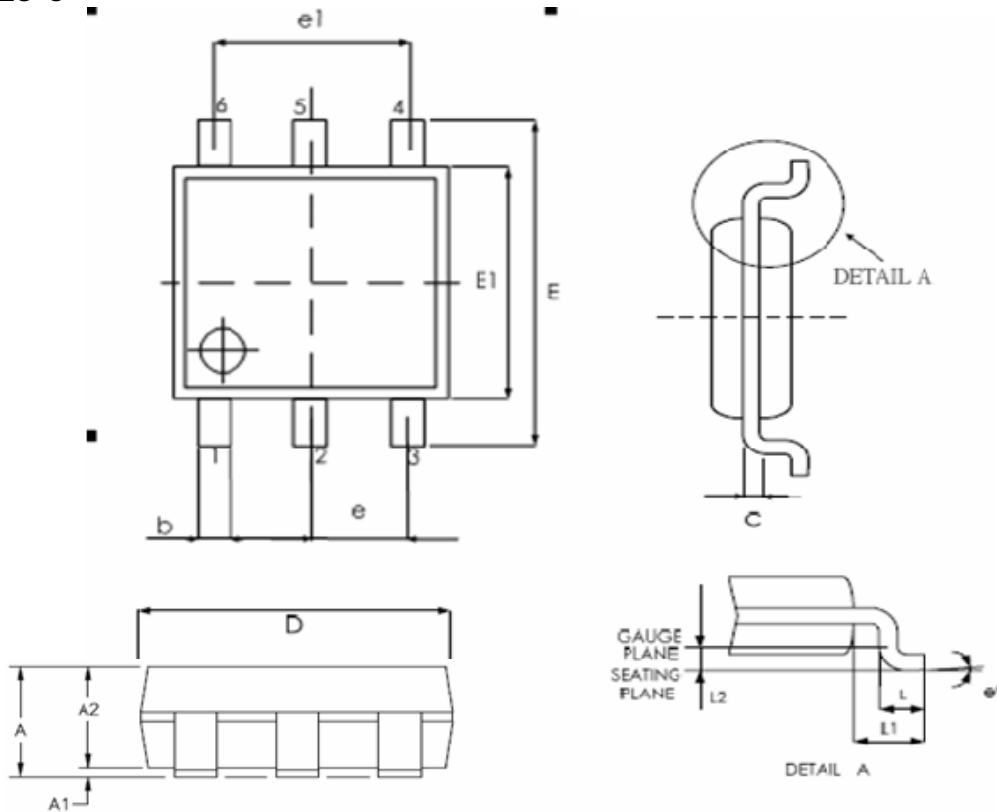

SYMBPLS	MIN.	NOM.	MAX.
A	—	—	1.45
A1	0	—	0.15
A2	0.90	1.15	1.30
b	0.30	—	0.50
c	0.08	—	0.22
D	2.70	2.90	3.10
E	2.60	2.80	3.00
E1	1.50	1.60	1.70
e	0.95 BSC		
e1	1.90 BSC		
L	0.30	0.45	0.60
L1	0.60 REF		
L2	0.25 BSC		
$\theta^\circ$	0	4	8

UNIT: MM

## Revision History

Revision	Date	Description
5.0	2009.03.24	EMP transferred from version 4.2
5.1	2010.01.13	order information/GRR definition (page 2)
5.2	2011.09.22	1.Add product ID 2.Revise SOT23-6 outline spec

**Important Notice**

All rights reserved.

No part of this document may be reproduced or duplicated in any form or by any means without the prior permission of ESMT.

The contents contained in this document are believed to be accurate at the time of publication. ESMT assumes no responsibility for any error in this document, and reserves the right to change the products or specification in this document without notice.

The information contained herein is presented only as a guide or examples for the application of our products. No responsibility is assumed by ESMT for any infringement of patents, copyrights, or other intellectual property rights of third parties which may result from its use. No license, either express, implied or otherwise, is granted under any patents, copyrights or other intellectual property rights of ESMT or others.

Any semiconductor devices may have inherently a certain rate of failure. To minimize risks associated with customer's application, adequate design and operating safeguards against injury, damage, or loss from such failure, should be provided by the customer when making application designs.

ESMT's products are not authorized for use in critical applications such as, but not limited to, life support devices or system, where failure or abnormal operation may directly affect human lives or cause physical injury or property damage. If products described here are to be used for such kinds of application, purchaser must do its own quality assurance testing appropriate to such applications.